

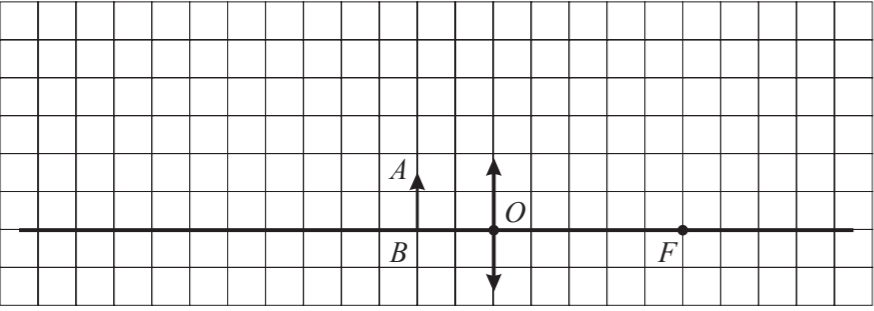

**6 klausimas**

1. 

2. 

3. 

4. 

**7 klausimas**

1. Fotosrovės stipris proporcingas ....., o fotoelektronų greitis priklauso nuo ..... ir elektrodo medžiagos.

2. 

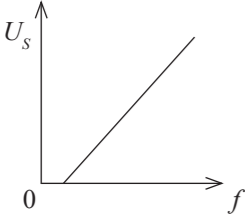
3. 

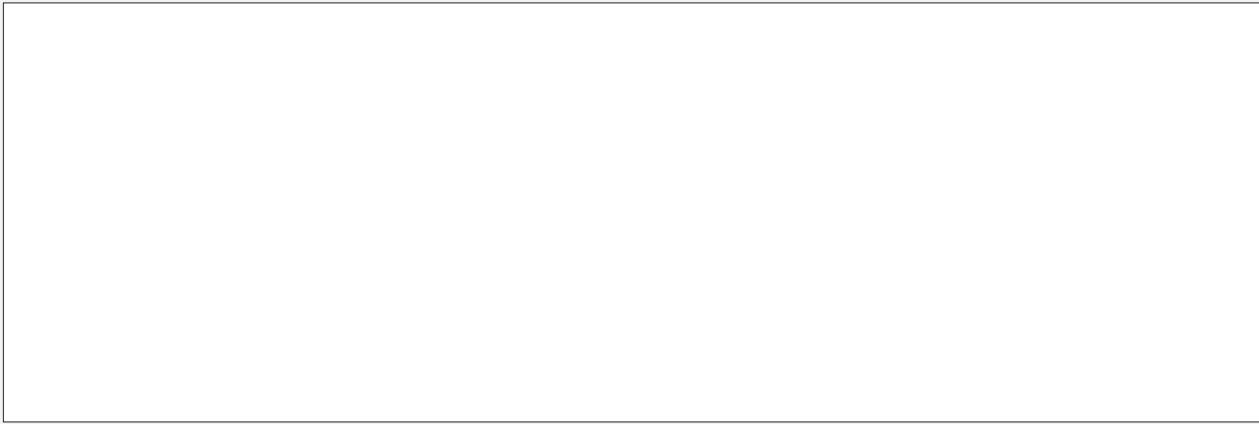
4. 

Vertintojai		
I	II	III
		1. (3)
		2. (3)
		3. (1)
		4. (2)
		(9)
		1. (2)
		2. (1)
		3. (1)
		4. (3)
		(7)

**ATSAKYMŲ LAPAS**

Nacionalinis egzaminų centras

Čia priklijuokite kandidato kodą

I VERTINTOJO KODAS

II VERTINTOJO KODAS

III VERTINTOJO KODAS

**I DALIS**

Teisingą atsakymą  žymėkite taip:

	A	B	C	D		A	B	C	D		A	B	C	D
07.	<input type="checkbox"/>	<input type="checkbox"/>	<input type="checkbox"/>	<input type="checkbox"/>	15.	<input type="checkbox"/>	<input type="checkbox"/>	<input type="checkbox"/>	<input type="checkbox"/>	23.	<input type="checkbox"/>	<input type="checkbox"/>	<input type="checkbox"/>	<input type="checkbox"/>
08.	<input type="checkbox"/>	<input type="checkbox"/>	<input type="checkbox"/>	<input type="checkbox"/>	16.	<input type="checkbox"/>	<input type="checkbox"/>	<input type="checkbox"/>	<input type="checkbox"/>	24.	<input type="checkbox"/>	<input type="checkbox"/>	<input type="checkbox"/>	<input type="checkbox"/>
09.	<input type="checkbox"/>	<input type="checkbox"/>	<input type="checkbox"/>	<input type="checkbox"/>	17.	<input type="checkbox"/>	<input type="checkbox"/>	<input type="checkbox"/>	<input type="checkbox"/>	25.	<input type="checkbox"/>	<input type="checkbox"/>	<input type="checkbox"/>	<input type="checkbox"/>
10.	<input type="checkbox"/>	<input type="checkbox"/>	<input type="checkbox"/>	<input type="checkbox"/>	18.	<input type="checkbox"/>	<input type="checkbox"/>	<input type="checkbox"/>	<input type="checkbox"/>	26.	<input type="checkbox"/>	<input type="checkbox"/>	<input type="checkbox"/>	<input type="checkbox"/>
11.	<input type="checkbox"/>	<input type="checkbox"/>	<input type="checkbox"/>	<input type="checkbox"/>	19.	<input type="checkbox"/>	<input type="checkbox"/>	<input type="checkbox"/>	<input type="checkbox"/>	27.	<input type="checkbox"/>	<input type="checkbox"/>	<input type="checkbox"/>	<input type="checkbox"/>
12.	<input type="checkbox"/>	<input type="checkbox"/>	<input type="checkbox"/>	<input type="checkbox"/>	20.	<input type="checkbox"/>	<input type="checkbox"/>	<input type="checkbox"/>	<input type="checkbox"/>	28.	<input type="checkbox"/>	<input type="checkbox"/>	<input type="checkbox"/>	<input type="checkbox"/>
13.	<input type="checkbox"/>	<input type="checkbox"/>	<input type="checkbox"/>	<input type="checkbox"/>	21.	<input type="checkbox"/>	<input type="checkbox"/>	<input type="checkbox"/>	<input type="checkbox"/>	29.	<input type="checkbox"/>	<input type="checkbox"/>	<input type="checkbox"/>	<input type="checkbox"/>
14.	<input type="checkbox"/>	<input type="checkbox"/>	<input type="checkbox"/>	<input type="checkbox"/>	22.	<input type="checkbox"/>	<input type="checkbox"/>	<input type="checkbox"/>	<input type="checkbox"/>	30.	<input type="checkbox"/>	<input type="checkbox"/>	<input type="checkbox"/>	<input type="checkbox"/>

Jei suklydote atsakydami į klausimus su pasirenkamaisiais atsakymais, taisyti galite čia. Parašykite tik taisomo klausimo numerį ir pažymėkite kitą pasirinktą atsakymą (žr. pavyzdį). Anksčiau pasirinkto atsakymo nebraukite. **Būkite atidūs!**

Kl. Nr.	A	B	C	D	Kl. Nr.	A	B	C	D
<input type="checkbox"/>	<input type="checkbox"/>	<input type="checkbox"/>	<input type="checkbox"/>	<input type="checkbox"/>	<input type="checkbox"/>	<input type="checkbox"/>	<input type="checkbox"/>	<input type="checkbox"/>	<input type="checkbox"/>
Kl. Nr.	A	B	C	D	Kl. Nr.	A	B	C	D
<input type="checkbox"/>	<input type="checkbox"/>	<input type="checkbox"/>	<input type="checkbox"/>	<input type="checkbox"/>	<input type="checkbox"/>	<input type="checkbox"/>	<input type="checkbox"/>	<input type="checkbox"/>	<input type="checkbox"/>

PAVYZDYS    0 0   

**II DALIS**

1. Varža	<input type="checkbox"/>	Vertintojai	I	II	III	6. <input type="checkbox"/> <input type="checkbox"/> Ω	Vertintojai	I	II	III
2. Dažnis	<input type="checkbox"/>				(1)	7. <input type="checkbox"/> <input type="checkbox"/> <input type="checkbox"/> m				(1)
3. Jėgos impulsas	<input type="checkbox"/>				(1)	8. <input type="checkbox"/> , <input type="checkbox"/> J				(1)
4. Mechaninė įtampa	<input type="checkbox"/>				(1)	9. <input type="checkbox"/> mm				(1)
5. Pusėjimo trukmė	<input type="checkbox"/>				(1)	10. <input type="checkbox"/> , <input type="checkbox"/> × 10 <sup>-30</sup> kg				(1)

II dalies taškų suma  (10)

III DALIS

1 klausimas



2.

3.

4.

5.

Vertintojai		
I	II	III
		1. (1)
		2. (2)
		3. (2)
		4. (2)
		5. (1)
		(8)

2 klausimas

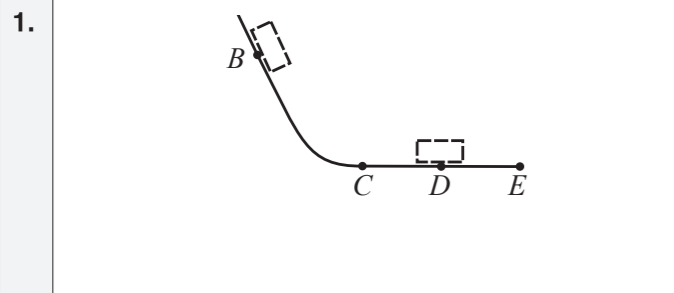

2.

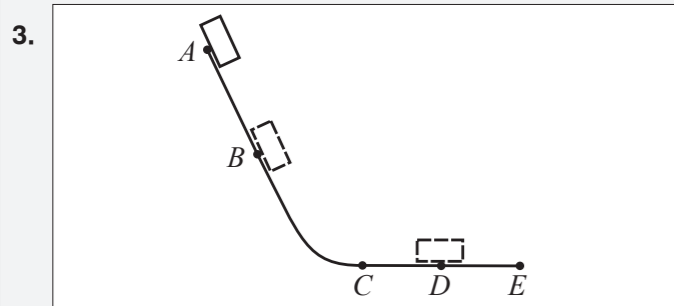

4.

1.

2.

3.

		1. (3)
		2. (3)
		3. (1)
		4. (2)
		(9)

3 klausimas

		1. (2)
		2. (3)
		3. (2)
		(7)

4 klausimas

1.

3.

4.

5.

6.

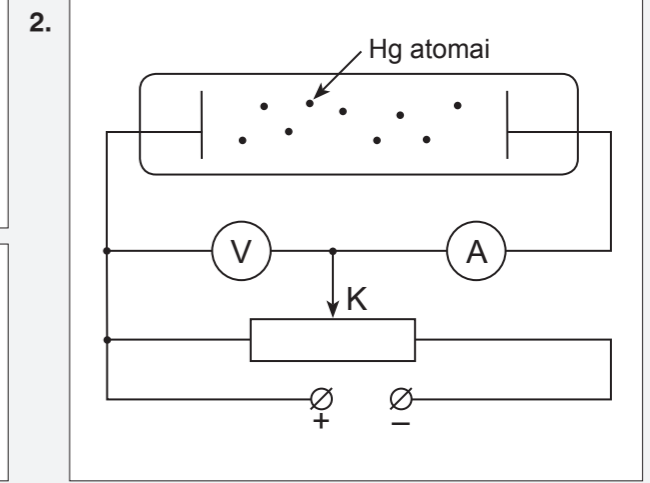

Vertintojai		
I	II	III
		1. (1)
		2. (1)
		3. (2)
		4. (2)
		5. (1)
		6. (3)
		(10)

5 klausimas

1.

2.

3.

4.

		1. (2)
		2. (3)
		3. (3)
		4. (2)
		(10)